

SoloTech™

Peristaltic Hose Pumps

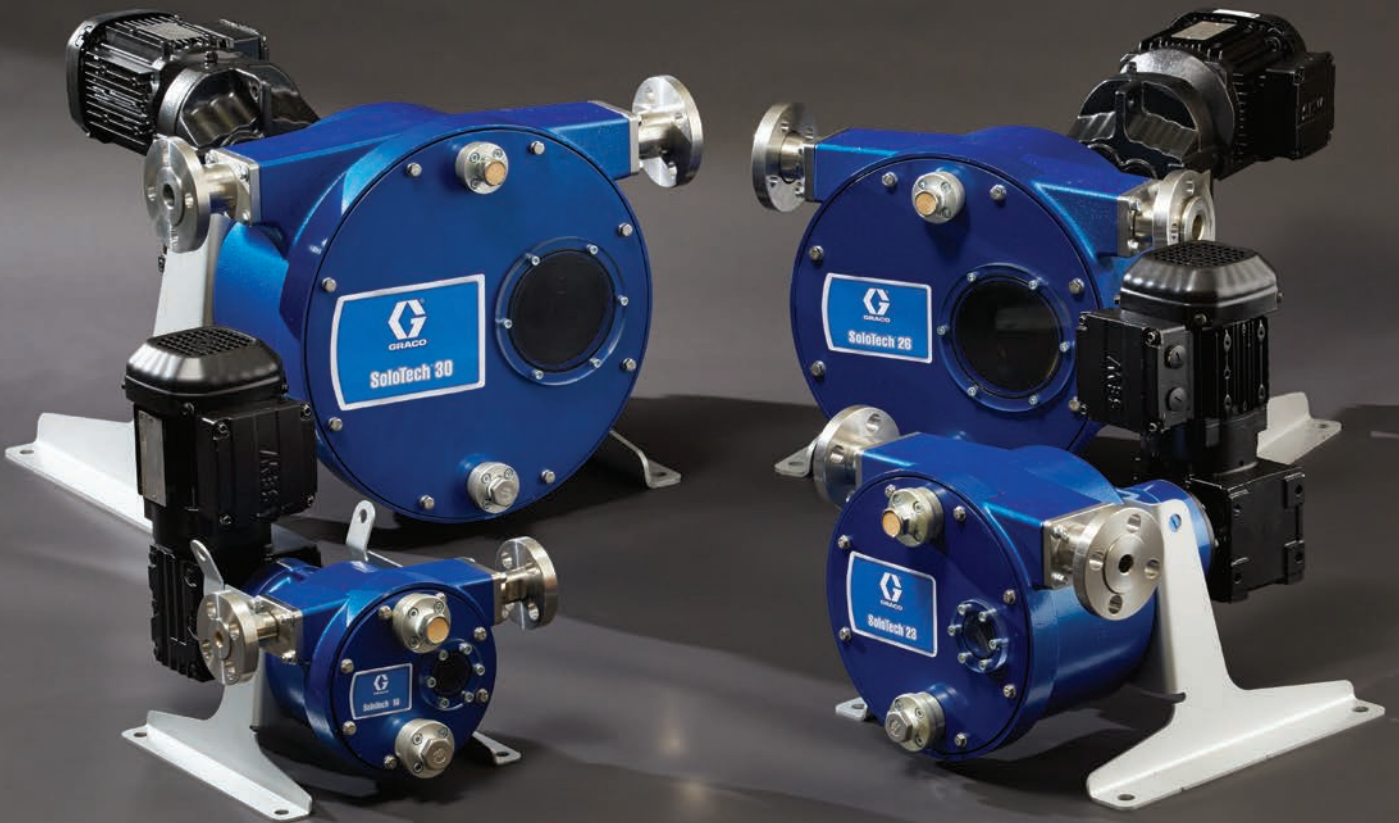

Single roller compresses an engineered hose through a full 360-degrees of rotation

- More flow per revolution than conventional designs
- Inexpensive to maintain – no valves, seals or glands
- Pumps are reversible and can be used to empty lines or clear blockages
- Extended hose life – only one hose compression per revolution
- No special tools needed to change the hose, just a standard screwdriver

Built to handle your Toughest Jobs

Performance

- A** LAC Motor (low speed)
- B** MAC Motor (medium speed)
- C** HAC Motor (high speed)
- D** MPM Brushless DC motor
- ▭ Indicates the recommended continuous duty range

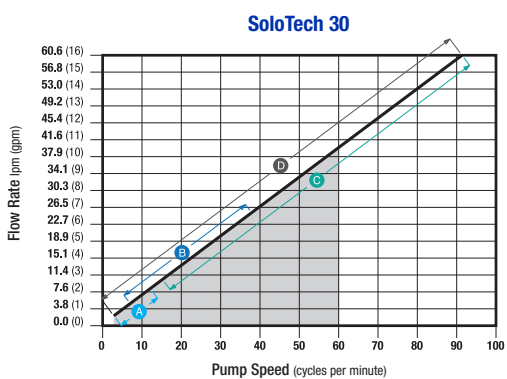
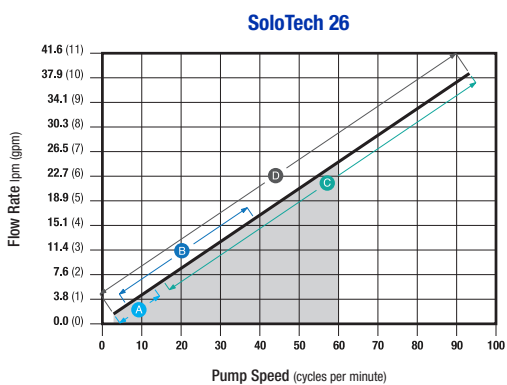
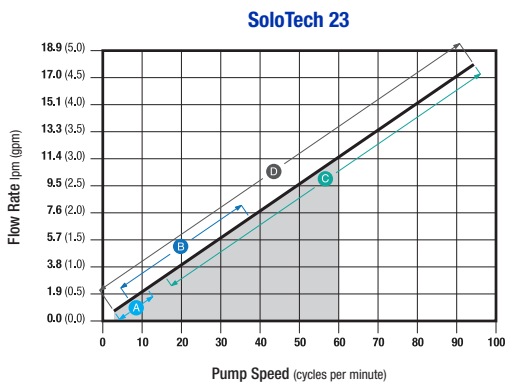
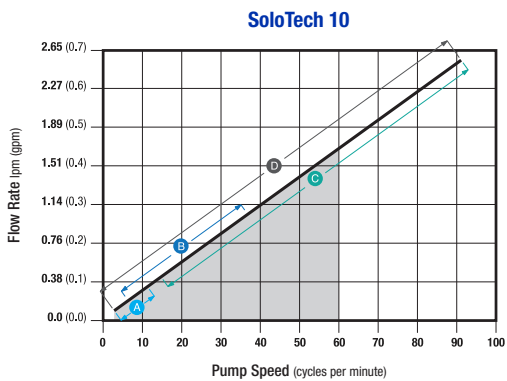

Why a Graco SoloTech Hose pump:

- **360° Hose:**
Gives you up to 50% more flow per revolution increasing hose lifetime
- **Many Control Options:**
Batch control, pressure control, leak detection, PLC connection
- **Motor Options:**
AC, AC ATEX, Brushless DC, IEC Flange (no motor)
- **Hose Design:**
With only the hose in contact with the fluid being pump and no check valves in line, Graco's SoloTech peristaltic pumps are ideal for materials that other pumps cannot handle. Abrasive, corrosive, shear sensitive, and gas entrapped fluids can easily be pumped or dosed into your application.

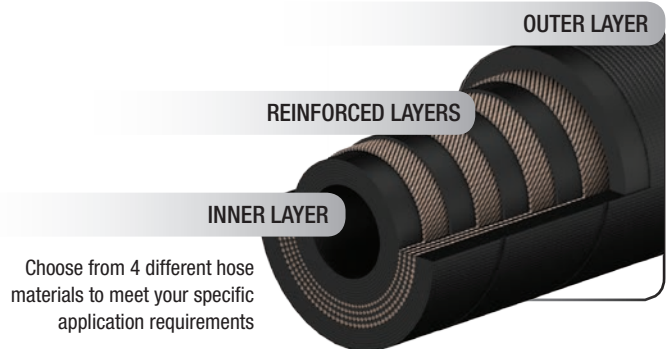

What are you pumping?

It's critical to choose the right pump for your application. Hose and barb failures are caused by poor chemical compatibility or excessive wear, leading to unexpected downtime. Our experts will help you select the correct pump to prevent these failures in the field.

Need more assurance? Our **Brushless DC pump** will remind you when it's time to change your hose before it shuts your process down!

Hose Materials	Stripe Colour / Inside Colour	Max. Fluid Temperature	Application Area
Natural Rubber (NR)	None / Black	71°C (160°F)	Abrasives
Chlorosulfonated polyethylene (CSM)	Orange / Black	121°C (250°F)	Highly corrosive chemicals
Nitrile	Yellow / Black	104°C (220°F)	Oils or oily products
Ethylene propylene (EPDM)	Blue / Black	121°C (250°F)	Corrosive chemicals



SoloTech™ - Peristaltic Hose Pumps

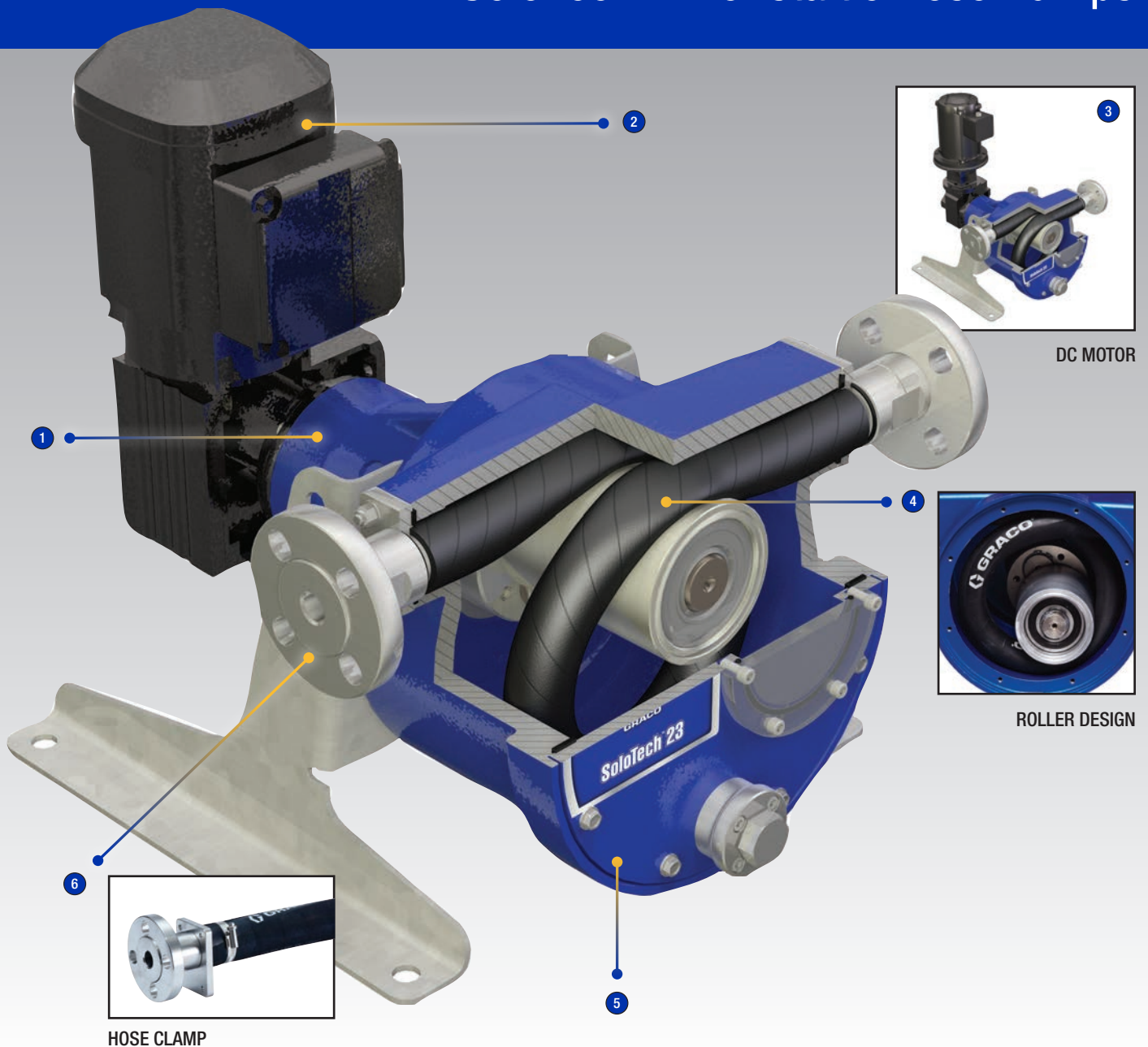

1 Pump Construction

- Cast aluminum housing reduces pump weight
- Improved mounting flexibility with sheet metal feet

2 AC Electric Motor

- AC, AC ATEX with multiple gearbox offerings to meet your exact flow rate needs

3 DC Motor

- Pressure control
- Batching dispense mode
- Wider operating range means you can cover the full range with only one gearbox

4 Roller Design

- Single roller design improves hose life by reducing the number of compressions, temperature and friction
- New metallic roller with bearings provides constant compression and flow

5 Removable Cover

- Aluminum covers with larger sight window makes it easy to access internal parts
- Optional leak detector kit mounts on cover

6 Hose Clamp Assembly

- Upgraded hose barb and clamp assembly
- Easy to install or remove - no special tools needed
- Available with PVDF and SST barbs options
- Flange connections

Models with IEC flange (no motor) also available

SoloTech™

Peristaltic Hose Pumps

Technical Specifications

Model	SoloTech 10			SoloTech 23			SoloTech 26			SoloTech 30		
Hose Size	10 mm			23 mm			26 mm			30 mm		
Max flow - lpm (gpm)	92 rpm = 2.5 (0.67)			94 rpm = 17 (4.5)			93 rpm = 37.1 (9.8)			91 rpm = 59.8 (15.8)		
Flow - liter/rev (gallon/rev)	0.03 (0.007)			0.20 (0.054)			0.42 (0.11)			0.68 (0.18)		
Pump Speed Range	Low	Mid	High	Low	Mid	High	Low	Mid	High	Low	Mid	High
Gearbox Ratio	157:1	48:1	19.5:1	157:1	48:1	19.13:1	145:1	47:1	19.27:1	150:1	48:1	19.7:1
Horsepower	0.25	0.50	0.75	0.25	0.75	1.00	0.33	1.00	2.00	0.50	1.50	3.00
Pump Speed @ 60 Hz - rpm	11	37	92	11	37	94	12	38	93	12	37	91
Flow Rate @ 60 Hz - lpm (gpm)	0.32 (0.085)	1.02 (0.27)	2.60 (0.685)	2.16 (0.57)	7.15 (1.89)	17.98 (4.75)	5.11 (1.35)	15.82 (4.18)	38.54 (10.18)	7.95 (2.1)	24.80 (6.55)	60.57 (16.0)
Maximum Working Pressure	8.6 bar (125 psi)			8.6 bar (125 psi)			8.6 bar (125 psi)			8.6 bar (125 psi)		
Maximum Suction Lift - m (ft)	8.9 (29)			8.9 (29)			8.9 (29)			8.9 (29)		
Pump Inlet / Outlet Size	DIN PN16 010 - 3/8 in, ANSI 150 1/2 NPS, JIS 10K 010			DIN PN16 020 - 3/4 in, ANSI 150 1 NPS, JIS 10K 020			DIN PN16 020 - 3/4 in, ANSI 150 1 NPS, JIS 10K 020			DIN PN16 025 - 1 in, ANSI 150 1-1/4 NPS, JIS 10K 025		
Operation Manual	334859			334859			334859			334859		
Repair Parts Manual	3A3367			3A3367			3A3367			3A3367		

Popular Models* (AC models don't include VFD controls, DC models include Graco controls)

Part No.	Hose Size	Motor	Gear Reduction	Hose Material	Barb Material
19Z001	10 mm	Brushless DC w/ Graco Controller	10 mm DC (37.66:1)	Natural Rubber	SST
19Z003	10 mm	Brushless DC w/ Graco Controller	10 mm DC (37.66:1)	CSM	PVDF
19X002	10 mm	IEC Flange (no motor)	Low (157.43:1)	CSM	SST
19Z010	10 mm	AC Motor	Low (157.43:1)	CSM	SST
19Z017	10 mm	AC Motor	Mid (48.00:1)	Natural Rubber	SST
19Z033	23 mm	Brushless DC w/ Graco Controller	23 mm DC (37.66:1)	Natural Rubber	SST
19Z035	23 mm	Brushless DC w/ Graco Controller	23 mm DC (37.66:1)	CSM	PVDF
19Z041	23 mm	AC Motor	Low (157.43:1)	NR	SST
19Z053	23 mm	AC Motor	Mid (48.00:1)	CSM	PVDF
19Z065	26 mm	Brushless DC w/ Graco Controller	26 mm DC (38.23:1)	Natural Rubber	SST
19Z066	26 mm	Brushless DC w/ Graco Controller	26 mm DC (38.23:1)	CSM	SST
19Z092	26 mm	AC Motor	Mid (47.32:1)	Nitrile	SST
19Z073	26 mm	AC Motor	High (19.54:1)	Natural Rubber	SST
19Z097	30 mm	MPM	30 mm DC (36.6:1)	Natural Rubber	SST
19Z106	30 mm	AC Motor	Mid (48.00:1)	CSM	SST
19Z113	30 mm	AC Motor	High (19.70:1)	Natural Rubber	SST

* To find a complete listing of all SoloTech pump options and a list of VFD's, see manual number 334859.

All written and visual data contained in this document are based on the latest product information available at the time of publication. Graco reserves the right to make changes at any time without notice.

Graco is certified ISO 9001.

Authorized Graco Distributor:

Stavanger Korrosjon AS • Strandbakken 3, 4072 Randaberg • Norway

Tel: +47 51410711 • Fax: +47 51410299 • E-mail: post@stavanger-korrosjon.no • <http://www.stavanger-korrosjon.no>

GRACO BVBA Industrieterrein Oude Bunders • Slakweidestraat 31 • B-3630 Maasmechelen Tel: +32 (89) 770 700 • Fax: +32 (89) 770 777 • <http://www.graco.com>

©2016 Graco BVBA 345080ENEU Rev. C 04/16 Printed in Europe.
All other brand names or marks are used for identification purposes and are trademarks of their respective owners.

